



Feel the possibilities.
Cooling & Heating Solutions
from Mitsubishi Electric

Comfort | Efficiency | Health



MULTI-ZONE OUTDOOR UNIT

DUCTED UNIT

CEILING CASSETTE

WALL MOUNT

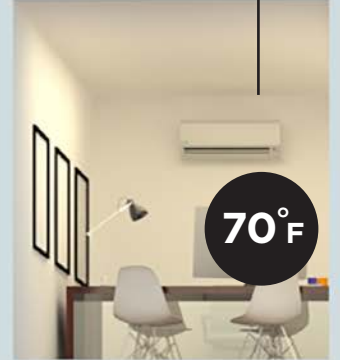
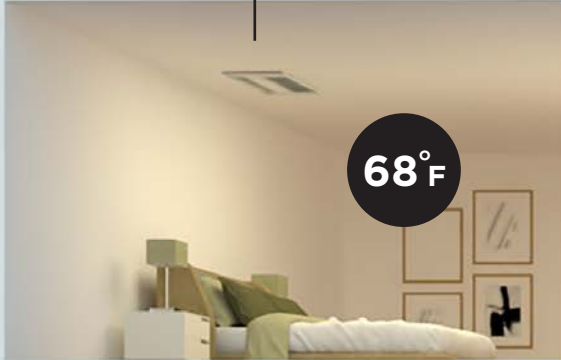

Take full control of your monthly bills and comfort with room-by-room control - a more efficient way to cool and heat your home or business.



Unmatched Quality, Uncompromising Control

Mitsubishi Electric is the top selling brand of zoned air conditioning and heating systems. You will enjoy cleaner air and superior control of cooling, heating and your monthly energy bill. In addition to being quiet, intelligent and efficient, our systems provide extraordinary service life for a lower cost of ownership.

Define Your Comfort Zones

With this technology, it's simple to assign your bedrooms, kitchen, living room, office, basement and other spaces to different "zones" so each room is always comfortable. Once you decide what temperature you'd like a specific zone to be, the system will quietly maintain that temperature while using the least amount of energy needed. For additional energy savings, you have the option to not cool and heat unused rooms.



KJ Series Floor Mount

Technology that puts comfort in your hands.

The essential components of a zoned air conditioning and heating system are the outdoor unit, the indoor unit and the smart comfort controls. The system operates by transferring heat to and from an outdoor unit to one or more indoor units. The units are connected by pipes containing refrigerant, a substance that absorbs heat.

In cooling mode, the refrigerant absorbs heat inside the home and produces colder air by transferring refrigerant from the indoor units to the outdoor unit, where the heat is expelled. In heating mode, the process is reversed and the refrigerant absorbs heat outside of the home and provides warmth by transferring the refrigerant from the outdoor unit to the indoor units. This method of heat transfer — which works even in freezing weather — is powered by electricity and is much greener than conventional systems that burn fossil fuels during heating.

The outdoor unit is equipped with an INVERTER that enables it to quickly change the amount of power it uses and the amount of refrigerant it transfers to and from the indoor units. With the INVERTER, the outdoor unit only uses the precise amount of power needed to reach each zone's preferred temperature.

Live In A Cold Climate?

Even in outside temperatures as cold as -13° F, our Hyper-Heating INVERTER® (H2i®) technology will keep your home and business comfortable. Well-suited for climates in the northern half of the United States, H2i systems continue to provide heating when temperatures drop well below zero.



Diagram of the heat transfer between the outdoor unit and indoor unit during heating operation

Maximize efficiency and minimize your power bill.

The less sophisticated, conventional air conditioning and heating systems run at full power until it reaches a set temperature and then stops, only to turn on again — sometimes within an hour — as the temperature becomes uncomfortable. Each time the system turns on its noisy outdoor unit, it uses more energy than it does during regular operation.

The INVERTER, at the heart of our system, eliminates the wasteful start and stop cycle. Just as your heart always beats, but automatically beats faster when you exercise, the system is always active with the INVERTER enabling it to automatically adjust conditioning when its temperature sensors detect even subtle changes. You don't have to think about it and the system is so quiet you won't hear it either. Rooms are cooled and heated faster and more efficiently. The INVERTER regulates energy consumption so that the system only uses the precise amount of energy needed to keep each room at the temperature you choose. This is greener and more sustainable than running at full power like conventional systems and can reduce energy consumption by up to 40 percent.



POWER CONSUMPTION

Annual savings of up to 40% with the INVERTER Advantage



COOLING MODE

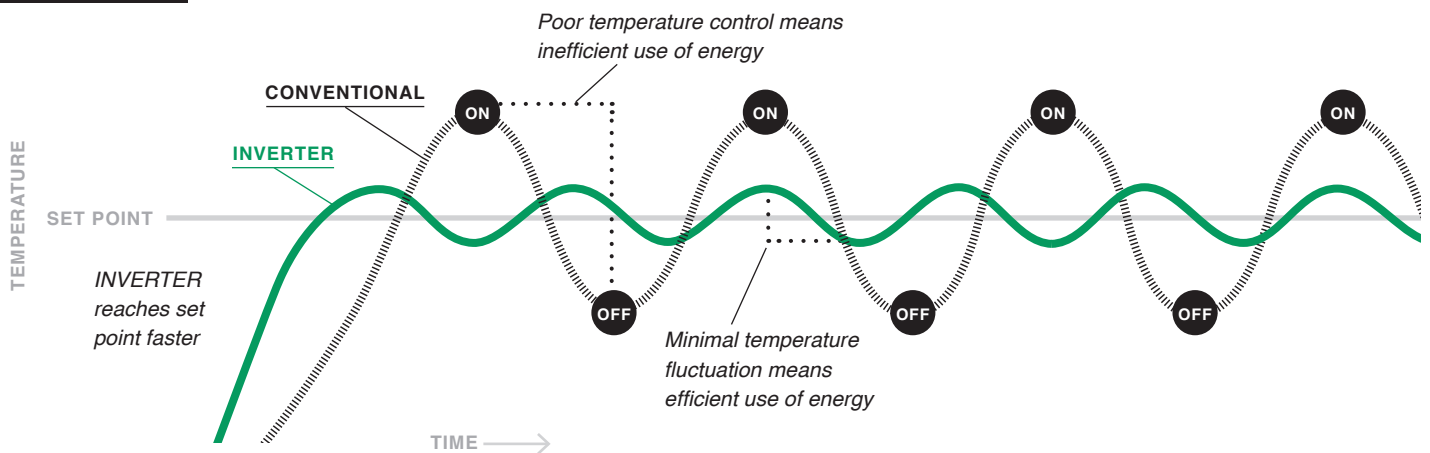



Ducted Air Handler



Single-zone System

SINGLE-ZONE

One outdoor unit connects to one indoor unit

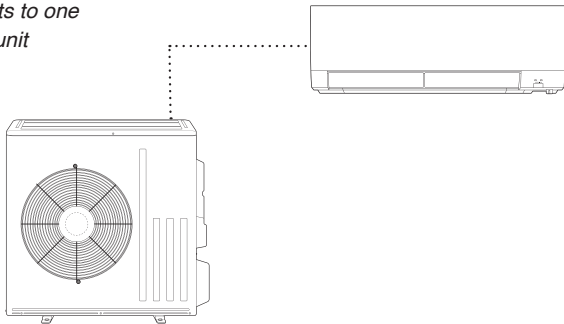

MULTI-ZONE

One outdoor unit can connect up to eight indoor units

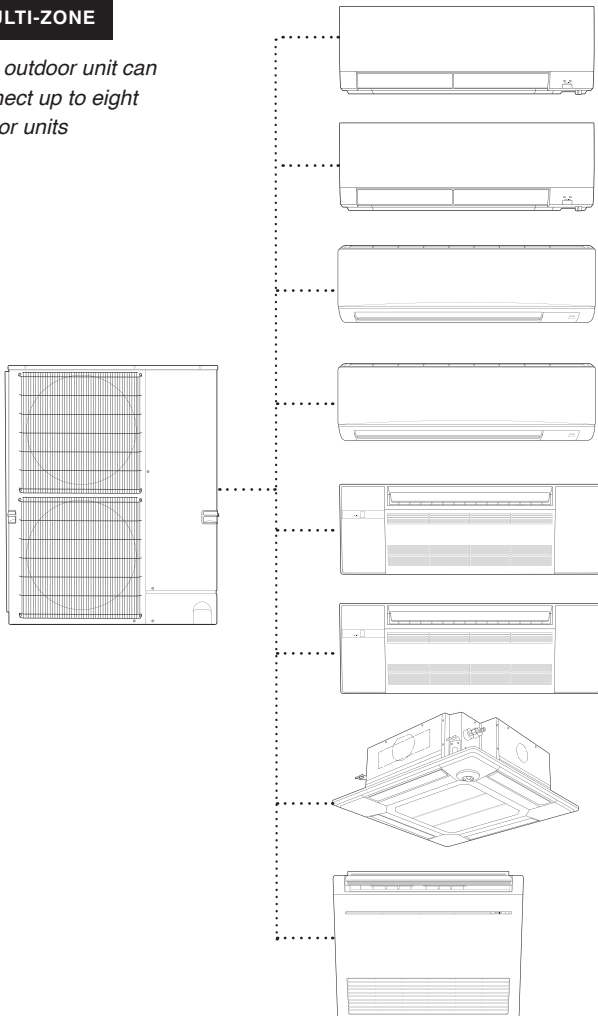

Outdoor units and indoor units are available in single-zone and multi-zone versions.

With single-zone equipment, one outdoor unit connects to one indoor unit (see pages 18-25 for indoor units available). This option is ideal if you only need cooling and heating in a single space.

With multi-zone equipment, one outdoor unit can connect up to eight indoor units. This option is perfect if you need cooling and heating in multiple spaces with different functions, such as a nursery versus a kitchen or an office versus a conference room.

Each zone is served by its own indoor unit. Indoor units come in a variety of forms including wall-mounted units, floor-mounted units, ceiling cassettes and air handlers.

Wall-mounted units tend to be the most popular, but a floor-mounted unit could be an attractive option for a sunroom that has windows, but no wall space. A high-performance air handler could replace an older system, such as a central system or boiler that previously cooled or heated an open space.

Breathe easier with an indoor unit.

Our indoor units don't just keep each room in your home at the perfect temperature; they continuously clean the air of allergens, dust, viruses and bacteria. Each room's indoor unit is equipped with filters to directly improve your air quality while the conventional system has only one filter installed in the central unit. The filters are washable and last up to 10 years, which saves you money on maintenance. Filters available for our indoor units include:

Nano Platinum Filter

This filter incorporates nanometer-sized platinum-ceramic particles that kill bacteria and deodorize air.

Deodorizing Filter

These platinum deodorizing filters use nanotechnology to absorb odors and neutralize the worst smells.

Anti-Allergy Enzyme Filter

This electrostatic, anti-allergy enzyme filter uses an enzyme catalyst to break down allergen proteins and transform them into non-allergen proteins. That means lose the sneezing, but keep the cat.



ANTI-ALLERGEN

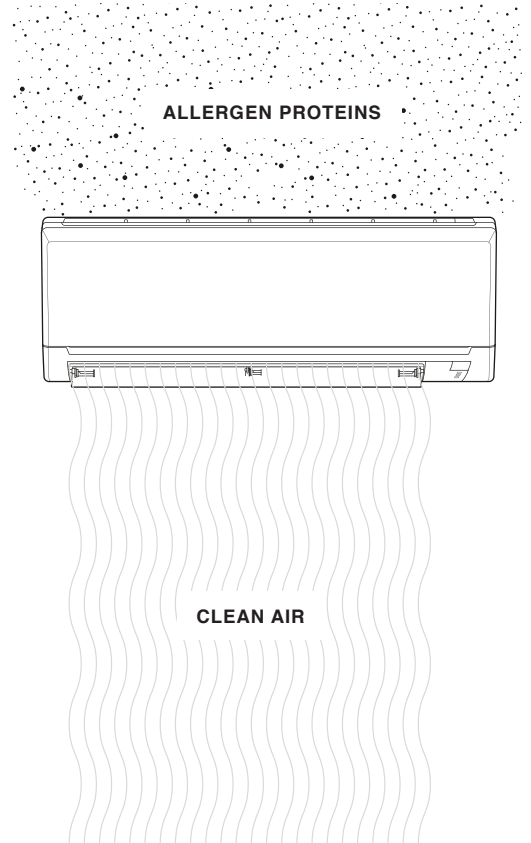



GL Series Wall Mount



PLA Ceiling Cassette

Smart comfort solutions designed around you.

3D i-see Sensor®

Available with select indoor unit models, the 3D i-see Sensor increases the sensitivity of the system to your comfort needs and gives you opportunities to further customize comfort in your home or business. The sensor scans each room to produce a complete thermal profile that includes heat signatures based upon size, temperature and movement. With this capability, the 3D i-see Sensor can detect and eliminate cold or hot spots and can determine whether a room is occupied. Here are some of the ways your indoor units can automatically adjust conditioning and airflow based upon the 3D i-see Sensor.

Advanced Occupant Detection

Select ceiling-recessed indoor unit models are equipped with sensors that rotate a full 360° in three-minute intervals. This allows the units to detect human body temperature and use an algorithm that calculates the number of people in the room as well as their positions.

Indirect Airflow

This setting is useful when the occupant does not wish to have air blowing directly on them.

Direct Airflow

If you want your indoor units to send airflow directly toward occupants.

Absence Detection

When no one is in the room, the 3D i-see Sensor can direct your indoor units to enter an energy-saving mode.

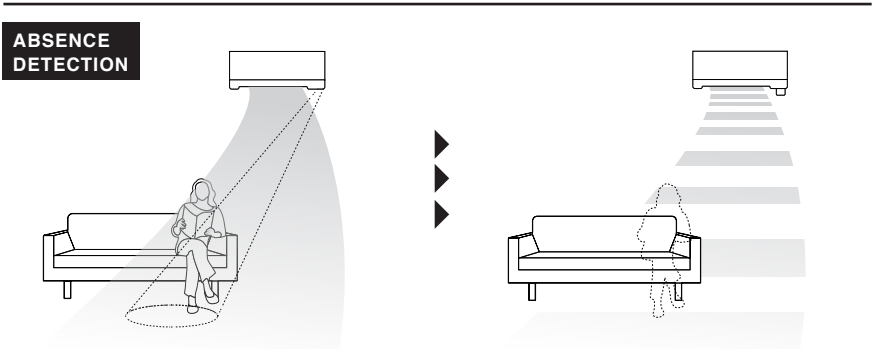
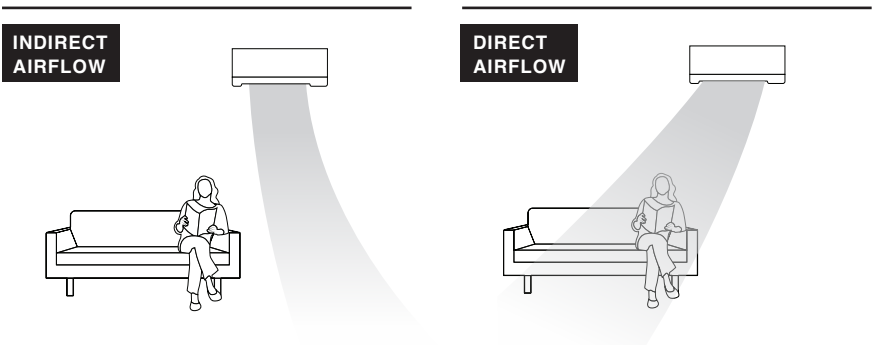
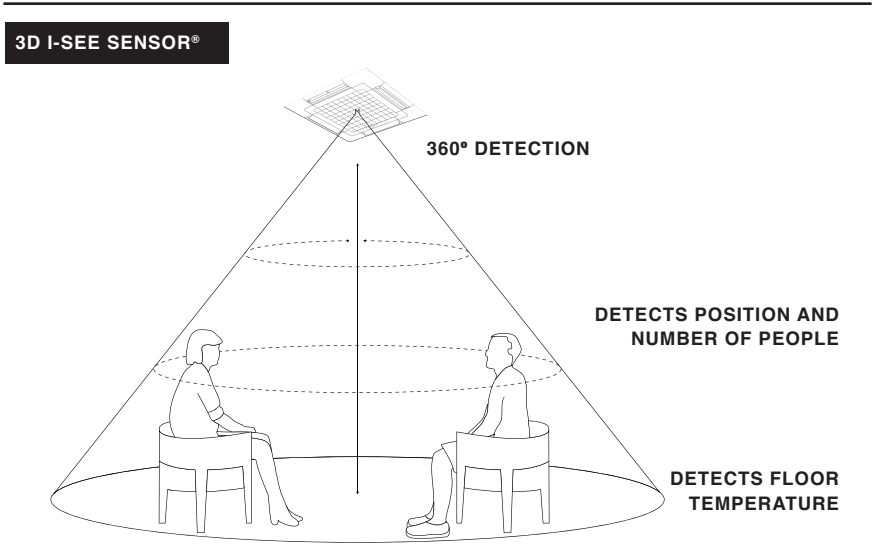

Get a comprehensive overview of your energy usage with tools to control energy consumption in your home or workspace, no matter where you happen to be.



**kumo touch™
Wireless Controller**

Easy to operate with a traditional user interface, the kumo touch™ Wireless Remote Controller Kit can be mounted on any wall. With no need to pull a wire toward hard-to-reach locations, this wireless controller is great for retrofits. Set custom schedules so that rooms in your home or business are ready at your preferred temperatures at the time you choose. Operation modes available through this controller include cool, drying, auto, heat and fan.



Deluxe MA Controller

Among its management features, this backlit, wall-mounted controller includes a settings screen for the 3D i-see Sensor®.



Touch MA Controller

Fully customized touch panel with 180 color patterns available. Personalize screen with company logo.



Simple MA Controller

This controller can control up to 16 indoor units.



Standard



Advanced

Handheld Controllers

A handheld controller comes standard with wall-mounted, floor-mounted and ceiling cassette indoor units. The controller style varies by indoor unit to support each indoor unit's product features. Advanced controllers are offered on products with additional features such as vane control and 3D i-see Sensor® technology.

Thermostat Interface: This interface enables you to control your comfort using your favorite thermostat.

BACnet® and Modbus® Interface: If you use a Building Management System (BMS) or a home automation system such as Crestron®, this interface will enable you to control M-Series and P-Series indoor units using your existing system.

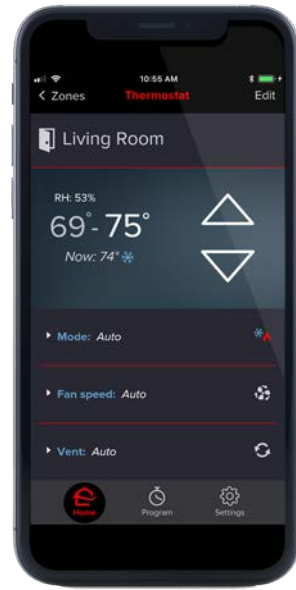

Comfort control in the palm of your hand.

kumo cloud® is part of the intelligence behind the system. With a patent-pending algorithm, kumo cloud automatically switches the system from cooling mode to heating mode and back as needed to give you perfect year-round comfort. When paired with **kumo station**®, kumo cloud can also automatically manage the operation of third-party furnaces, boilers, heaters, humidifiers, dehumidifiers and ventilators. kumo cloud accessories include an outside air temperature sensor to gather even more complete actionable information about your total thermal environment.

On your smartphone or tablet, the kumo cloud app enables you to effortlessly control temperatures, adjust fan speeds, set modes and custom schedules, check the status of your filters and much more from anywhere. Whether you are gone for the day, or away for a month, kumo cloud provides you with a secure connection and the ability to manage multiple zones and even multiple locations such as both your home and your business.

Additionally, kumo cloud works with Amazon Alexa and Google Assistant. Control your comfort with your voice or ask for the current temperature or humidity in a room. Expand your heating and cooling system with IFTTT Applet integration built into the kumo cloud app. This integration allows you to control transfer fans, lighting and much more.

kumo cloud is compatible with all current Mitsubishi Electric systems including M-Series and P-Series.



Which outdoor unit is right for me?

Say goodbye to the noisy outdoor units of conventional systems. Our outdoor units operate as low as 46 decibels — the level of a typical conversation. Each unit has a space-saving compact design and is available in a variety of sizes to suit different cooling and heating requirements.



Multi-zone System

Single-Zone

Available as a cooling only, heat pump or a hyper-heating heat pump, each outdoor unit connects to a single indoor unit through refrigerant lines. These outdoor units have INVERTER-driven compressors that only use the precise amount of energy needed to keep the space comfortable.

Multi-Zone

Available as a heat pump or an H2i® hyper-heating heat pump, each outdoor unit is capable of connecting up to eight indoor units. These outdoor units have INVERTER-driven compressors that only use the precise amount of energy needed to keep the space comfortable.



Photos © 2018 Scripps Networks, LLC. Used with permission; all rights reserved.

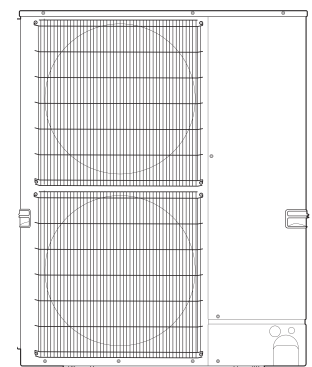
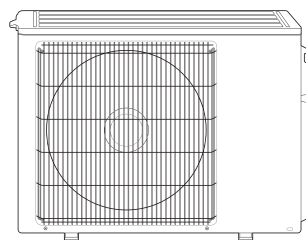
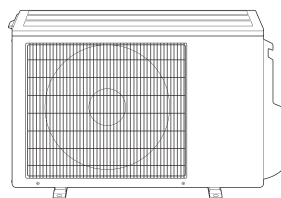
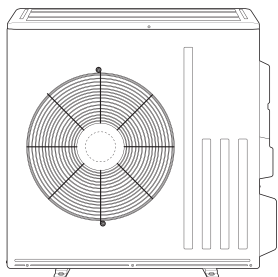



Which indoor unit is right for me?

With Mitsubishi Electric you can choose from a wide-array of indoor units that reflect the cooling and heating needs, aesthetic and purpose of your space.

MLZ Ceiling Cassette

As you look at the styles of indoor units on the next few pages, these icons will indicate what options and capabilities are available for the units in each series. A series may include multi-zone and single-zone options as well as units of varying sizes.

ZONING



SINGLE-ZONE

One outdoor unit connects to one indoor unit and provides comfort in one zone.



MULTI-ZONE

One outdoor unit connects to up to eight indoor units and provides comfort in multiple zones.

ENERGY SAVING



I-SEE SENSOR

The 3D i-see Sensor scans each room to produce a complete thermal profile that includes heat signatures based upon size, temperature and movement.



ECONO COOL

Econo Cool adjusts the amount of air directed towards occupants based on the air-outlet temperature.

AIR QUALITY



NANO-PLATINUM FILTER

Incorporates nanometer-sized platinum-ceramic particles that kill bacteria and deodorize air.



ELECTROSTATIC ANTI-ALLERGY ENZYME FILTER

Charged with static electricity, this filter attracts and captures dust particles, molds and bacteria and breaks them down with enzymes.

AIR DISTRIBUTION



SWING

An indoor unit with this capability can move air throughout the room like an oscillating fan.



POWERFUL MODE

Powerful Mode temporarily drops or raises the set temperature for 15 minutes so that automatic fan speed adjustments made possible by the INVERTER will more quickly bring your room to your desired temperature.

OTHER



LIGHT COMMERCIAL

Units marked with this icon are suitable for light commercial applications such as small offices, restaurants and retail.

INDOOR UNITS

Wall-Mounted Units

Wall-mounted units are the most versatile and popular style of indoor units. Slim, stylish and equipped with filters to continuously clean indoor air, these units sit high on the wall and are ideal for conditioning smaller areas such as individual rooms in a home, office or store. This indoor unit option does not require ductwork.



FH MODEL

Karen Culp Photography | KCULP.COM

Available as single-zone or multi-zone units, FH models include high-end features enabled by the 3D i-see Sensor® such as occupancy detection, direct mode and indirect mode. Whisper-quiet operation as low as 20 decibels eliminates unnecessary noise while air filters eliminate unwanted smells, particulates and allergens.



EF MODEL

Our Designer Series EF wall-mounted units combine sophisticated technology and design. With clean lines and three finishes – glossy black, matte silver or glossy white – the Designer Series complements a variety of decor and style preferences. The Designer Series runs quietly, at noise levels as low as 21 decibels.

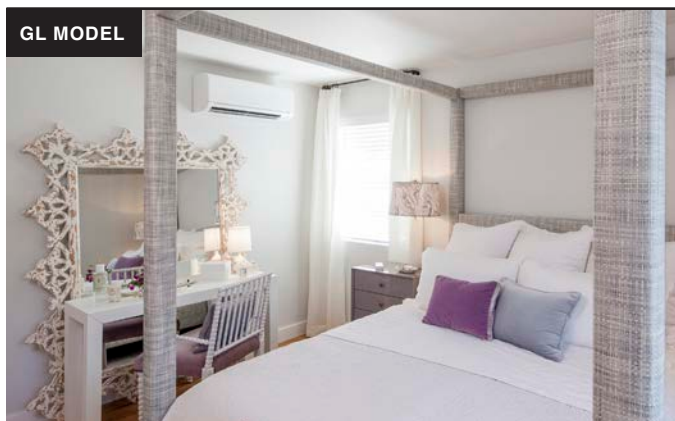

GL MODEL

With compact designs, and a wide-range of available sizes, the GL model of wall-mounted units keep rooms of nearly any size comfortable. The GL model includes the MSZ-GL heat pump which is available as a single-zone or multi-zone unit and the MSY-GL, a single-zone, cooling only unit for climates where heating is unnecessary. At 19 decibels, the GL model has the lowest noise levels in the industry.

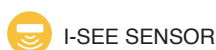

HM MODEL

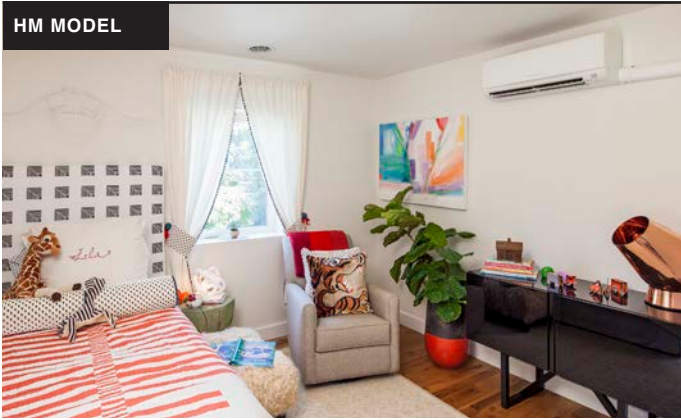

This basic heat pump is available as a single-zone unit and keeps operating noise as low as 22 decibels.



JP MODEL



Available as a single-zone 115 volt heat pump are ideal for homes or hotels with electrical service restrictions.



D MODEL

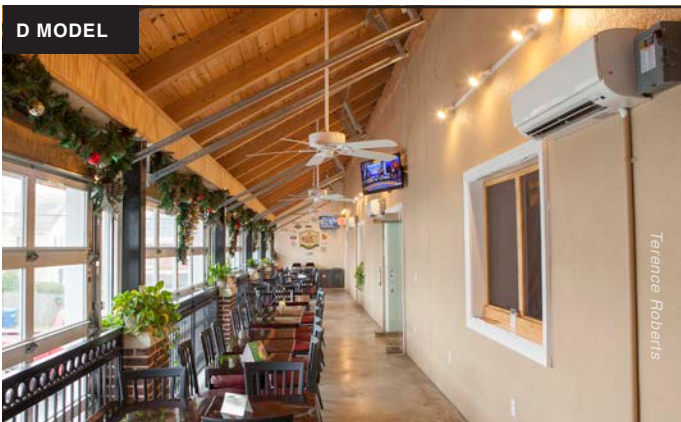

These large capacity standard wall-mounted units have Wide Airflow capabilities to ensure air reaches every corner of a room and includes the Powerful Mode feature for rapid cooling and heating. Options include a single-zone, cooling only model for climates where heating is unnecessary.



PKA MODEL

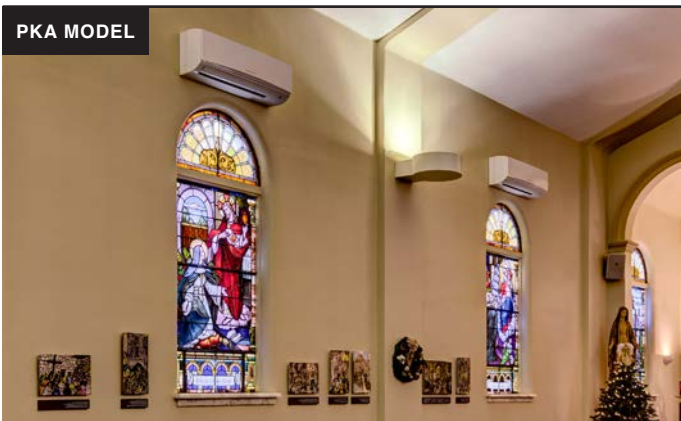

These multi-zone, light commercial models are ideal for classrooms, daycare centers, small offices, server rooms and more.



Ceiling-Mounted Units

Ceiling-mounted options include ductless cassettes installed flush to the ceiling and ductless ceiling-suspended units for light commercial settings.



MLZ MODEL

Ideal for retrofits, these multi-zone cassettes feature a sleek, narrow-body design resting flush to the ceiling with a service panel easily accessed from below. Perfect for residential, hotel and office spaces, MLZ units are equipped with auto vane technology to adjust air direction based upon your needs and advanced filtration capabilities.

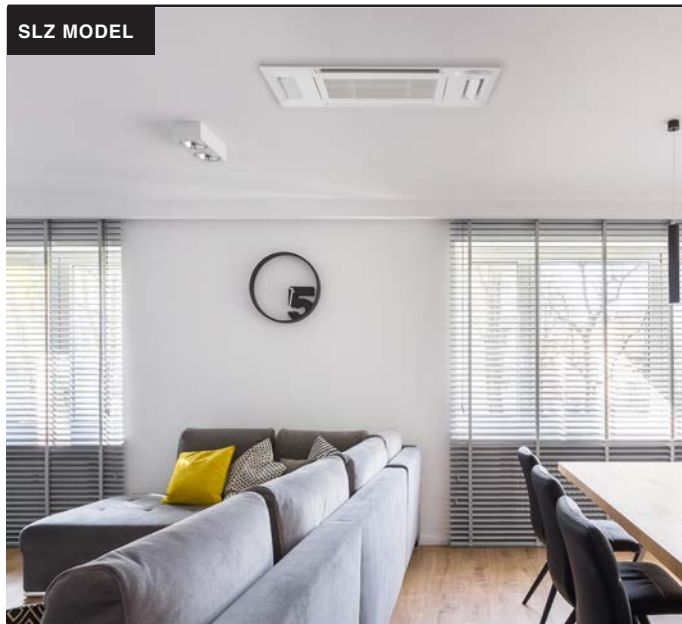
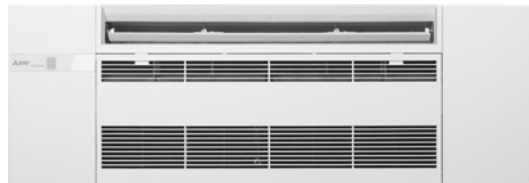

SLZ MODEL

These single- and multi-zone cassettes are designed to fit into a 2' x 2' suspended ceiling grid and mounted flush with the ceiling. A four-way air outlet provides maximum comfort by evenly distributing airflow throughout the entire room. Consider applying the SLZ with a short duct run to condition a small adjacent space. The SLZ model is available with an optional 3D i-see Sensor[®] providing ultimate comfort control.



* Optional



SINGLE-ZONE



MULTI-ZONE



I-SEE SENSOR



ECONO COOL



NANO-PLATINUM FILTER

PLA MODEL



Designed for large, open floor plans such as school, office and retail settings, these multi-zone cassettes neatly fit into standard ceiling tiles. Four-way air outlets with individual vane settings permit up to 72 different airflow patterns. Additional comfort and efficiency controls are available if installed with the optional 3D i-see Sensor®.



PCA MODEL



These single- and multi-zone models mount suspended from the ceiling and are ideal for larger retail stores, commercial kitchens, classrooms and office spaces. Additional comfort and efficiency controls are available if installed with the optional i-see Sensor.



Floor-Mounted Units

These slim, floor-mounted units can be mounted partially recessed into the wall. Best used in a home, store or restaurant space, this is a great option if you are replacing radiators or want a unit in your sunroom or attic.



Available as single-zone and multi-zone models, these units are equipped with H2i Hyper-Heating® technology, rapid heating capabilities and a multi-flow vane to control airflow throughout a space.



Horizontal-Ducted Units

Flexible in design, and perfect for residential and hospitality settings, these units can be hidden in the ceiling or beneath the floor.



Available as a single-zone or multi-zone unit, these low static units are designed to cool and heat one or two rooms through a short duct run. The SEZ series may be mounted in the attic, hidden in the ceiling or beneath the floor, or concealed behind a bulkhead.

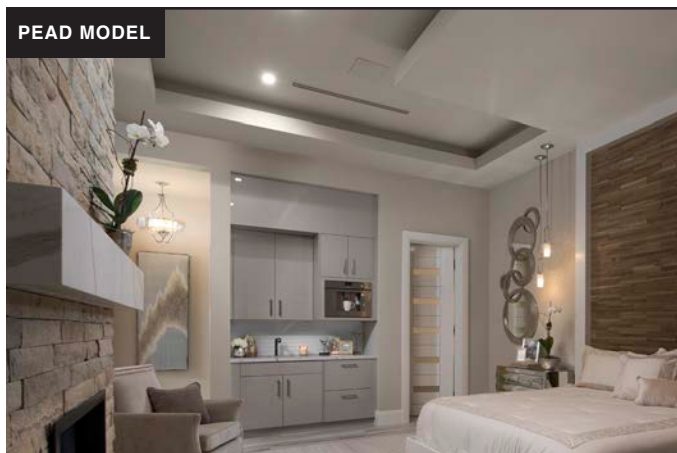

Available as a single-zone or a multi-zone unit, the PEAD series offers low capacities suitable for Passive Houses and large capacities suitable for light commercial uses such as offices, retail and restaurants. These medium static units are capable of serving large spaces or multiple rooms from a longer duct run. The PEAD series may be mounted in the attic, hidden in the ceiling or beneath the floor or concealed behind a bulkhead.

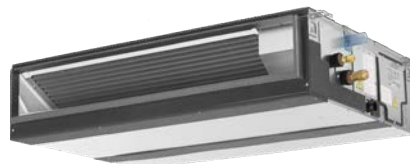

Ducted Air Handlers

Designed with compact cabinets, these units can provide powerful and efficient cooling and heating with or without ductwork. Ideal for residential, store or restaurant settings, a ducted air handler with INVERTER-driven capabilities is a perfect solution for new buildings. This is also applicable for upgrading or replacing furnace systems and air handlers.



SVZ MODEL

These compact and quiet air handlers can be paired with the MXZ and the SUZ Universal Outdoor Unit for INVERTER-driven efficiency best appreciated while reviewing utility bills.



PVA MODEL

These single-zone air handlers offer large capacities and are appropriate for large homes, multi-family buildings and light commercial spaces such as offices and restaurants. The PVA series offers long line lengths and can be installed horizontally or vertically.



ELECTROSTATIC ANTI-ALLERGY ENZYME FILTER



SWING



POWERFUL MODE



LIGHT COMMERCIAL

GLOSSARY

ENERGY SAVING

ENERGY STAR: the unit has received ENERGY STAR® certification

3D i-see Sensor®: scans each room to produce a complete thermal profile that includes heat signatures based upon size, temperature and movement

Econo Cool: adjusts the amount of air directed towards occupants based on the air-outlet temperature

Demand Function: when the unit is equipped with a commercially available timer or an On/Off switch added to the outdoor unit, a signal input from the outside can help reduce energy consumption

Blue Fin: particularly beneficial in coastal areas, this anti-corrosion treatment to the heat exchanger of the outdoor units prevents the corrosion caused by salt in the air that impacts the efficiency and performance of the units

HSPF: a ratio of BTU heat output over the heating season to watt-hours of electricity used. The higher the HSPF rating of a unit, the more energy efficient it is.

SEER: the rating of a unit's cooling output during a typical cooling-season divided by the total electric energy input during the same period. The higher the unit's SEER rating, the more energy efficient it is.

AIR QUALITY

Nano Platinum Filter: incorporates nanometer-sized platinum-ceramic particles that kill bacteria and deodorize air

Catechin Filter: improves air quality and offers an excellent deodorizing effect by incorporating catechin, a bioflavonoid derived from green tea

Air Filter: removes dust particles from the air

Deodorizing Filter: this filter captures and breaks down odor-causing particles to eliminate unwanted smells

Electrostatic Anti-allergy Enzyme Filter: charged with static electricity, this filter attracts and captures dust particles, molds and bacteria and breaks them down with enzymes

Anti-allergy Enzyme Filter: traps allergens such as molds and bacteria and decomposes them using enzymes

Air Purifying Filter: the filter has a large capture area and deodorizes the circulating air

Fresh Air Intake: indoor air quality is enhanced by the direct intake of fresh exterior air

High-efficiency Filter: the fine mesh of this high-performance filter is capable of capturing tiny particulates that other filters miss

Long-life Filter: this high-performance filter has a longer maintenance cycle than conventional filters

Filter Check Signal: operating time is monitored, and the user is notified when filter maintenance is necessary

AIR DISTRIBUTION

Double Vane: separates the airflow in different directions to deliver airflow across a wide area of the space and simultaneously to people in different locations

Swing: indoor unit moves air throughout the room like an oscillating fan

Indirect/Direct Mode: this mode offers finely-tuned operation by locating where an occupant is in the room and sends the air directly or indirectly according to the selected mode

Powerful Mode: temporarily drops or raises the set temperature for 15 minutes so that automatic fan speed adjustments made possible by the INVERTER will more quickly bring your room to your desired temperature

Wide Airflow: especially beneficial for large spaces, this capability helps ensure that air is well circulated and reaches every corner of the room

High Ceiling Mode: in the case of rooms with high ceilings, the outlet-air volume can be increased to ensure that air is circulated all the way to the floor

Low Ceiling Mode: if the room has a low ceiling, the airflow volume can be reduced for less draft

Auto Fan Speed Mode: adjusts the fan speed of the indoor unit automatically according to the present room conditions

CONVENIENCE

Smart Set: a simplified setting function that recalls the preferred (preset) temperature by pressing a single button on the remote controller

Weekly Timer: easily set desired temperatures and operation ON/OFF times to match your lifestyle

On/Off Timer: use the remote controller to set the times of turning the unit on and off

Auto Changeover: automatically switches between heating and cooling modes to maintain the desired temperature

Low-temperature Cooling: intelligent fan speed control on P-series outdoor units that ensures optimum performance even when the outside temperature is low

Auto Restart: especially useful at the time of power outages, the unit turns back on automatically when power is restored

Sleep Mode: 30 minutes after Sleep Mode is activated, the unit will change the daytime set temperature to the temperature you prefer while sleeping, automatically lowering the fan speed as necessary

PRODUCT COMPARISON MATRIX

ZONING

ENERGY SAVING

UNITS	Ductless	ENERGY STAR®	Light Commercial	Single-zone Cooling Only	Single-zone Heat Pump	Single-zone Hyper Heat	Multi-zone	Multi-zone Hyper Heat	3D i-see Sensor®	i-see Sensor®	Econo Cool™	Demand Function	Blue Fin	Nano Platinum Filter	Catechin Filter	Air Filter	Deodorizing Filter	Electrostatic Filter
-------	----------	--------------	------------------	--------------------------	-----------------------	------------------------	------------	-----------------------	------------------	---------------	-------------	-----------------	----------	----------------------	-----------------	------------	--------------------	----------------------

WALL-MOUNT

FH Model	●	●				●	●	●	●		●		●	●			●	●
EF Model	●						●	●			●			●				●
GL Model	●	●		●	●		●	●			●		●	●				●
D Model	●		●	●	●						●				●			
PKA Model	●		●	●	●	●						*						
HM/JP Model	●		*		●						●		●			●		

FLOOR-MOUNT

KJ Model	●	●				●	●	●				●		●	●			
----------	---	---	--	--	--	---	---	---	--	--	--	---	--	---	---	--	--	--

CEILING-MOUNT

MLZ Model	●	●				●	●	●	●			●		●				
SLZ Model	●	●	●			●	●	●	●	*				●				
PLA Model	●	●	●	●	●	●	●	●	●	*			*					
PCA Model	●		●	●	●	●	●	●	●	*			*					

HORIZONTAL-DUCTED

SEZ Model		●				●	●	●	●					●				
PEAD Model		●	●	●	●	●	●	●	●				*	●				

DUCTED-AIR HANDLER

SVZ Model		●				●	●	●	●					●				
PVA Model			●	●	●	●								*				

* Optional † GL24 Only © JP only

AIR QUALITY

AIR DISTRIBUTION

CONVENIENCE

Prostatic Anti-allergy Enzyme Filter	Anti-allergy Enzyme Filter	Air Purifying Filter	Fresh-air Intake	High-efficiency Filter	Long-life Filter	Filter Check Signal	Double Vane	Swing	Indirect/Direct Mode	Powerful Mode	Wide Airflow	High Ceiling Mode	Low Ceiling Mode	Auto Fan Speed Mode	Smart Set	Weekly Timer	On/Off Timer	Auto Changeover	Low-temperature Cooling	Auto Restart	Sleep Mode
--------------------------------------	----------------------------	----------------------	------------------	------------------------	------------------	---------------------	-------------	-------	----------------------	---------------	--------------	-------------------	------------------	---------------------	-----------	--------------	--------------	-----------------	-------------------------	--------------	------------

						●	●	●	●				●	●	●	●		●			
							●						●	●	●	●			●		
●							●		+	+			●	●		●	●		●		
●							●		●	●			●			●	●		●		
				●			●						●			●	●	●	●		
●							●						●			●	●		●		

●							●		●				●	●	●	●			●	●	
---	--	--	--	--	--	--	---	--	---	--	--	--	---	---	---	---	--	--	---	---	--

●	●						●				●		●	●	●	●			●	●	
		●		●	●		●	*			●	●	●			●	●		●	●	
		●		●	●		●	*			●	●	●			●	●	●	●	●	
		●	●		●		●					●				●	●	●	●	●	

													●			●	●		●		
					●								●			●	●	●	●	●	

													●			●		●			
													●			●	●	●	●	●	

One of the best warranties in the business.

Mitsubishi Electric products are supported by a trusted team of Diamond Contractors®. When you choose to work with a Diamond Contractor, not only do you get the benefit of their experience and expertise, but you can also increase the warranty on your purchase to 12 years.

12-YEAR WARRANTY

Most products that are installed and registered by a Diamond Contractor* within 90 days of installation receive a 12-year parts and compressor warranty. HM Model and WR model products are eligible for a maximum 10-year warranty.

10-YEAR WARRANTY

Products that are registered within 90 days of installation receive a 10-year parts and compressor warranty.

5- & 7-YEAR WARRANTIES

All products, regardless of registration, receive a five-year parts warranty and seven-year compressor warranty.

Visit **mitsubishicomfort.com** to find a Diamond Contractor in your area.

Mitsubishi Electric's air conditioning and heating systems are so energy efficient that a majority of our INVERTER-driven systems have received ENERGY STAR® certification. This efficiency can mean huge savings on your utility bills. Additionally, federal tax credits and rebates from utility companies and local governments may provide a further financial incentive for you to take full control of your comfort. Rebates come in many forms, from property and sales tax exemptions to loans and grants.

Visit the Rebates & Financing tab on mitsubishicomfort.com to search for available rebates.

*Diamond Contractors are independent specialists who are qualified by Mitsubishi Electric to find the best personal solution for your home. They are licensed installers and are certified in the latest product advancements of our cooling and heating systems.



© 2020 Mitsubishi Electric Trane HVAC US LLC. All rights reserved.
Mitsubishi Electric and the three-diamond logo are trademarks of Mitsubishi Electric Corporation. H2i and kumo cloud are registered marks of Mitsubishi Electric US, Inc. All other product names mentioned herein are trademarks or registered trademarks of their respective owners. ENERGY STAR and the ENERGY STAR mark are registered trademarks owned by the United States Environmental Protection Agency. Specifications shown in this brochure are subject to change without notice. See complete warranty for terms, conditions and limitations. A copy is available from Mitsubishi Electric.

ME_RS_1061_02-20 | Printed in the USA

1340 Satellite Boulevard, Suwanee, GA 30024
Phone: 800-433-4822 Fax: 800-658-1458
mitsubishicomfort.com

